

# YAESU

## VX-400

### Operating Manual

**YAESU MUSEN CO., LTD.**

4-8-8 Nakameguro, Meguro-Ku, Tokyo 153-8644, Japan

**YAESU U.S.A.**

17210 Edwards Rd., Cerritos, CA 90703, U.S.A.

**YAESU EUROPE B.V.**

P.O. Box 75525 1118 ZN, Schiphol, The Netherlands

**YAESU UK LTD.**

Unit 12, Sun Valley Business Park, Winnall Close  
Winchester, Hampshire, SO23 0LB, U.K.

**YAESU GERMANY GmbH**

Am Kronberger Hang 2, D-65824 Schwalbach, Germany

**YAESU HK LTD.**

11th Floor Tsim Sha Tsui Centre, 66 Mody Rd.,  
Tsim Sha Tsui East, Kowloon, Hong Kong

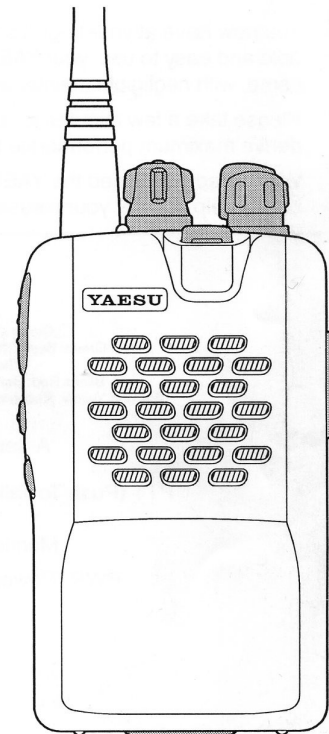

### Congratulations!

You now have at your fingertips a valuable communications tool—a **YAESU** two-way radio! Rugged, reliable and easy to use, your **YAESU** radio will keep you in constant touch with your colleagues for years to come, with negligible maintenance down-time.

Please take a few minutes to read this manual carefully. The information presented here will allow you to derive maximum performance from your radio, in case questions arise later on.

We're glad you joined the **YAESU** team. Call on us anytime, because communications is our business. Let us help you get your message across.

### Controls & Connectors

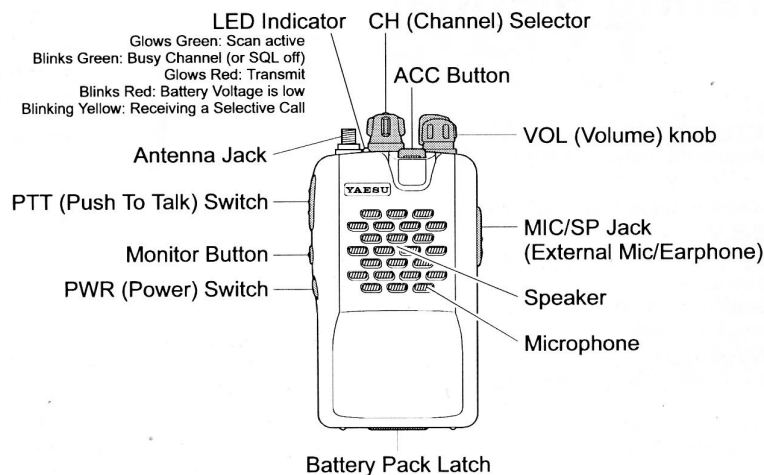

## BEFORE YOU BEGIN

### Battery Pack Installation and Removal

- To install the battery, hold the transceiver with your left hand, so your palm is over the speaker and your thumb is on the top of the belt clip. Insert the battery pack into the battery compartment on the back of the radio while tilting the Belt Clip outward, then close the Battery Pack Latch until it locks in place with a "Click."

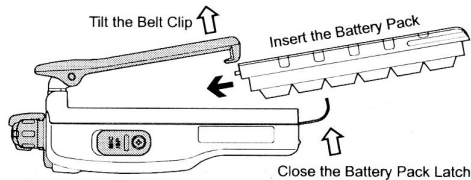

- To remove the battery, turn the radio off and remove any protective cases. Open the Battery Pack latch on the bottom of the radio, then slide the battery downward and out from the radio while unfolding the Belt Clip.



*Do not attempt to open any of the rechargeable Ni-Cd packs, as they could explode if accidentally short-circuited.*

### Low Battery Indication

- As the battery discharges during use, the voltage gradually becomes lower. When the battery voltage reaches 6.0 volts, substitute a freshly charged battery and recharge the depleted pack. The **TX/BUSY** indicator on the top of the radio will blink *red* when the battery voltage is low.
- Avoid recharging Ni-Cd batteries often with little use between charges, as this can degrade the charge capacity. We recommend that you carry an extra, fully-charged pack with you so the operational battery may be used until depletion (this "deep cycling" technique promotes better long-term battery capacity).

### Notice !

There are no owner-serviceable parts inside the transceiver. All service jobs must be referred to an authorized Yaesu Service Representative. Consult your Authorized Yaesu Dealer for installation of optional accessories.

## OPERATION

### Preliminary Steps

- Install a charged battery pack onto the transceiver, as described previously.
- Screw the supplied antenna onto the Antenna jack. Never attempt to operate this transceiver without an antenna connected.
- If you have a Speaker/Microphone, we recommend that it not be connected until you are familiar with the basic operation of the VX-400.

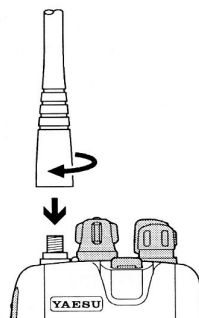

### Operation Quick Start

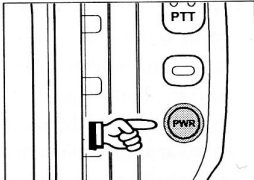
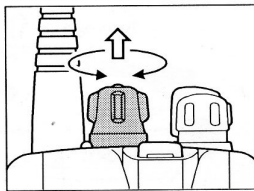
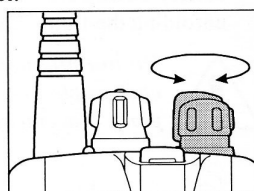
- To turn the radio on, press and hold the orange **PWR** button for 2 seconds. A multi-tone "beep" will confirm that the radio is now turned on. 
- *Pull and turn* the top panel's **CH** selector knob to choose the desired operating channel. If you select the channel position which has been programmed by your dealer as a "Scanning Start" channel (see following sections), the VX-400 will automatically begin scanning when you set the selector to that channel. 
- Rotate the top panel's **VOL** knob to set the volume level. If no signal is present, press and hold the **MONITOR** button (the middle button on the 

## OPERATION

left side) more than 2 seconds; background noise will now be heard, and you may use this to set the **VOL** knob for the desired audio level.

Press and hold the **MONITOR** button more than 2 seconds (or press the **MONITOR** button twice) to quiet the noise and resume normal (quiet) monitoring.

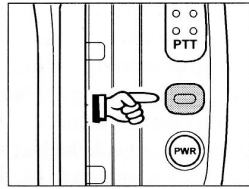

- To transmit, press and hold the **PTT** switch. Speak into the microphone area of the front panel grille (lower right-hand corner) in a normal voice level. To return to the Receive mode, release the **PTT** switch.
- If a Speaker/Microphone is available, remove the plastic cap and its mounting screw from the right side of the transceiver, then insert the plug from the Speaker/Microphone into the **MIC/SP** jack; secure the plug using the screw supplied with the Speaker/Microphone. Hold the speaker grille up

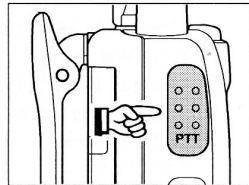

next to your ear while receiving. To transmit, press the **PTT** switch on the Speaker/Microphone, just as you would on the main transceiver's body.

**Note:** Save the original plastic cap and its mounting screw. They should be re-installed when not using the Speaker/Microphone.

- Press the top panel's **ACC** button to activate one of the pre-programmed functions which may have been enabled at the time of programming by the dealer. See the next section for details regarding the available features.

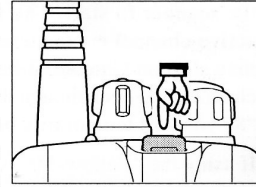

- When your communication is finished, switch off the radio by press and hold the orange **PWR** button for 2 seconds; a low "beep" tone will confirm that the radio is now turned off.

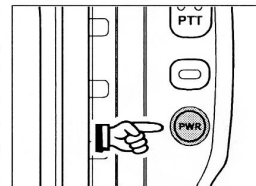

## OPERATION

### Scanning via CH Selector knob

Your Dealer may have programmed one channel to be a "Scanning Start" channel. For example, Channel 8 (the last channel to the right) might be designated as the "Scanning Start" channel. In this case, setting the **CH** Selector knob to Channel 8 will cause the scanner to start. The scanner will stop on any active channel encountered; therefore, the scanner may stop on Channel 3 because of activity on that channel, and even though the **CH** Selector knob reads "8" you will temporarily be receiving on Channel 3.

If using the "Follow-Me" scanning capability of this radio, the "Scanning Start" channel *may not be* designated as the User-Assigned Priority Channel.

## ACC BUTTON FUNCTIONS

The **ACC** button function can be customized, via programming by your Yaesu dealer, to meet your communications/network requirements. Some features may require the purchase and installation of optional internal accessories. The possible **ACC** button programming features are illustrated below, and their functions are explained on the next page. For further details, contact your Yaesu dealer. For future reference, check the box next to each function that has been assigned to the **ACC** button on your particular radio, and keep it handy.

- Channel Scan (/Priority Scan)
- Dual Watch
- Channel Bank Selection
- "Follow-Me" Scan
- Hi/Low Power
- Talk Around
- TX Save Disable
- Encryption Disable (requires the optional **FVP-25** Encryption/DTMF Paging Unit)

---

## ACC BUTTON FUNCTIONS

---

### ACC Function Descriptions

Only *one* of the **ACC** button functions will be available on your radio. Therefore, if “Channel Bank Selection” is enabled on your radio’s **ACC** button, Scanning will only be available if your Dealer designates one channel as a “Scanning Start” channel.

### Channel Scan (/Priority Scan)

Press the **ACC** button to start the scanner.

The scanner rapidly steps through each of the dealer programmed channels, looking for incoming calls. The scanner will pause when a signal is received.

The scanner will resume a few seconds after the signal is no longer present.

If a Priority Channel has been designated by your dealer, the radio will scan as above. When a station is heard on a (non-Priority) channel, the scanner will stop, then periodically it will check the Priority Channel for any incoming calls.

To stop the scanner, press the **ACC** button again. Operation will return to the channel to which the **CH** selector knob is set.

*Note:* Your Dealer may have programmed your radio to revert to the “Last Busy” channel or the Priority Channel if you press the **PTT** switch during the scanning pause. Contact your Dealer or Network Administrator for details on the programming of your VX-400.

### Dual Watch

Press the **ACC** button to activate the Dual Watch feature.

The Dual Watch feature automatically checks for activity on a Dealer-assigned Priority Channel while you are operating on another channel without using scanner. When a signal is received on the Priority Channel, operation immediately shifts to the Priority Channel.

To disable the Dual Watch feature, press the **ACC** button again.

---

## ACC BUTTON FUNCTIONS

---

### Channel Bank Selection

The 16 available channels in the VX-400 can be organized into 2 banks with up to 8 channels in each. Pressing the **ACC** button lets you select a bank for operation. Channels within each bank are selected using the **CH** selector knob.

### “Follow-Me” Scan

“Follow-Me” Scan feature checks a *User-assigned* Priority Channel regularly as you scan the other channels. Thus, if only Channels 1, 3, and 5 (of the 8 available channels) are designated for “Scanning,” the user may nonetheless assign Channel 2 as the “User-assigned” Priority Channel via the “Follow-Me” feature.

To activate “Follow-Me” scanning, *first* select the channel you want to designate as the “User-Assigned Priority Channel”, and press the **ACC** button. Then turn the **CH** selector knob to “Scanning Start” channel which has been Programmed by your dealer to activate the scanner. When the scanner stops on an “active” channel, the User-assigned Priority Channel will automatically be checked every few seconds; if activity is found on the User-assigned Priority Channel, the radio

will switch between it and the Dealer-Assigned Priority Channel, if any.

To set up a “Dual Watch” frequency pair using the “Follow Me” feature, select a channel using the **CH** selector knob. Now press the **ACC** button; pressing **ACC** locks the current channel as the User-assigned Priority Channel. Now rotate the **CH** Selector knob to another channel (*not the “Scanning Start” channel*). Your radio will now switch back-and-forth between the currently-selected channel (shown on the **CH** Selector knob) and the User-assigned Priority Channel.

During “Follow-Me” scanning (after you have pressed the **ACC** button), you can set up a “Dual Watch” feature by rotating the **CH** Selector knob to another channel. The radio will then scan back and forth between the original User-assigned Priority Channel and the newly-selected channel.

The Priority Channel you have assigned (before pressing the **ACC** button) will be retained in memory until you change it.

---

## ACC BUTTON FUNCTIONS

---

### Hi/Low Power

Pressing the **ACC** button switches the radio's transmitter to the "Low Power" mode, thus extending battery life. Press the **ACC** button again to return to "High Power" operation when in difficult terrain.

### Talk Around

Press the **ACC** button to activate the Talk Around feature when you are operating on *duplex* channel systems (separate receive and transmit frequencies, utilizing a "repeater" station). The Talk Around feature allows you to bypass the repeater station and talk *directly* to a station that is nearby. This feature has no effect when you are operating on "simplex" channels, where the receive and transmit frequencies are the same.

Note that your dealer may have made provision for "Talk Around" channels by programming "repeater" and "Talk Around" frequencies on two adjacent channels. If so, the **ACC** button may be used for one of the other PRE-PROGRAMMED FUNCTIONS.

### TX Save Disable

Press the **ACC** button to disable the Transmit Battery Saver, if you are operating in a location where high power is almost always needed.

The Transmit Battery Saver helps extend battery life by reducing transmit power when a very strong signal from an apparently nearby station is being received. Under some circumstances, though, your hand-held radio may not be heard well at the other end of the communication path, and high power may be necessary at all times.

### Encryption Disable

Pressing the **ACC** button will turn off the optional voice encryption unit temporarily, when an incorrect setting of (or failure in) the encryption system at one end of the communication path will make it impossible to talk the other station.

Remember that disabling the encryption will mean that your transmissions are no longer secure. Return to the encrypted mode as soon as possible, and do not discuss any critical or confidential information while in the non-encrypted mode of operation.

---

## UNDERSTANDING RADIO WAVES

---

Radio waves travel from one point to another by several different means. The general term for these methods of wave travel is "propagation". You may know that "shortwave" signals can be propagated over distances of several thousand miles by reflection off of the upper regions of the atmosphere.

Your hand-held transceiver, on the other hand, operates on the so-called VHF (Very-High Frequency) or UHF (Ultra-High Frequency) bands. On these band, radio waves usually do not reflect off of the atmosphere. Instead, the radio waves behave almost as light: they travel in a straight line, and when they meet a building or obstruction, they go no further in that direction.

Therefore, it is important that you be as high and free from obstructions as possible to cover the greatest distance when using your radio. If you operate from inside a car or building, any metal around you can absorb much of the signal, both transmitted and received. Coverage may therefore be very poor under those conditions. However, if you must operate from indoors, moving next to a window will improve communications.

In view of the factors just discussed, you can easily see the potential benefit of holding the radio up high near your mouth while transmitting. In this way the antenna

is high and clear, and coverage is best.

On final note regarding propagation is useful in improving coverage. Because radio waves at VHF and UHF are similar to light waves, they do reflect, to varying degrees, off of hills, buildings, and the like. In a crowded urban area, with many close buildings close together, many reflections may occur, and interfere with one another, causing variations in signal strength at different locations.

Therefore, if a signal is weak and you walk a few feet in any direction, reception may suddenly become clear, because a particular reflection path may become dominant. Reflections are frequently useful, as they can allow for communications between two stations over a highly obstructed path.

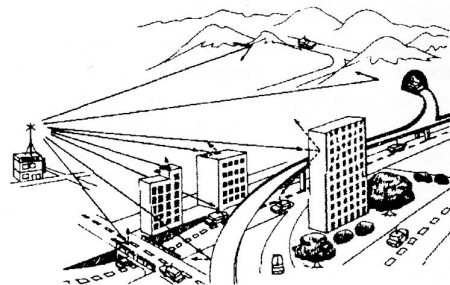

---

## SPECIFICATIONS

---

GENERAL	VX-400 (VUF)	VX-400 (UHF)
Frequency Range:	146-174 MHz	400-430, 440-470, 450-485, 485-512 MHz
Number of Channels:	16 channels (8+8)	16 channels (8+8)
Channel Spacing:	12.5/25/30 kHz	12.5/25/30 kHz
Battery Voltage:	7.2 VDC	7.2 VDC
Temperature Range:	-30°C to +60°C	-30°C to +60°C
Case Size (WHD):	58 x 101.6 x 25.4 mm w/FNB-V57	58 x 101.6 x 25.4 mm w/FNB-V57
Weight (approx.):	320 grams with FNB-V57, antenna, belt clip	320 grams with FNB-V57, antenna, belt clip
<b>RECEIVER</b>		
Circuit Type:	Double-conversion superheterodyne	Double-conversion superheterodyne
IFs:	21.7 MHz & 450 kHz	43.95 MHz & 450 kHz
12-dB SINAD Sensitivity:	< 0.2µV	< 0.25µV
Squelch Sensitivity:	< 0.25 µV	< 0.35 µV
Selectivity:	> 60 dB (12.5 kHz)/> 70 dB (25 kHz)	> 60 dB (12.5 kHz)/> 70 dB (25 kHz)
Intermodulation:	> 60 dB (12.5 kHz)/> 70 dB (25 kHz)	> 60 dB (12.5 kHz)/> 65 dB (25 kHz)
Spurious Rejection:	> 70 dB	> 70 dB
Image Rejection:	> 70 dB	> 70 dB
AF Output:	0.5 W @ 4 Ω, 5 % THD	0.5 W @ 4 Ω, 5 % THD
<b>TRANSMITTER</b>		
Power Output:	5.0/2.5/1.0/0.1 W (Selectable)	5.0/2.5/1.0/0.1 W (Selectable)
Frequency Stability:	better than ±5 ppm	better than ±5 ppm
Modulation System:	Direct FM	Direct FM
Maximum Deviation:	±2.5kHz (12.5 kHz)/±5 kHz (25 kHz)	±2.5kHz (12.5 kHz)/±5 kHz (25 kHz)
FM Noise:	> 35 dB (12.5 kHz)/> 40 dB (25 kHz)	> 35 dB (12.5 kHz)/> 40 dB (25 kHz)
Spurious Emission:	> 65 dB below carrier	> 65 dB below carrier
AF Distortion (@ 1 kHz):	< 2.5 %	< 2.5 %
Microphone Type:	2-k Ω condenser	2-k Ω condenser

Specifications are subject to change without notice or obligation.

---

## ACCESSORIES & OPTIONS

---

FVP-25	Encryption/DTMF Pager Unit
F2D-8	2-Tone Decode Unit
FNB-V57	7.2 V 1100 mAh Ni-Cd Battery
FNB-V57IS	Intrinsically-Safe 7.2 V 1100 mAh Ni-Cd Battery
FBA-25	Battery Case
NC-73	13.8 VDC Rapid Desk-Top Charger
NC-73B	120 VAC Rapid Desk-Top Charger
NC-73C	230-240 VAC Rapid Desk-Top Charger
NC-73F	220 VAC Rapid Desk-Top Charger
NC-73U	230 VAC Rapid Desk-Top Charger
VTP-50	VX-Trunk Unit
MH-34 <sub>D4B</sub>	Speaker/Microphone
MH-37 <sub>A4B</sub>	Earpiece Microphone
VC-25	VOX Headset
CT-42	PC Programming Cable
CT-27	Radio to Radio Programming Cable

---

---

**NOTE**

---

---

---

---

**NOTE**

---

---

This device complies with Part 15 of the FCC rules.  
Operation is subject to the condition that this device  
does not cause harmful interference.

---

# YAESU

*... leading the way.<sup>SM</sup>*

Copyright 2000  
Yaesu Musen Co., Ltd.  
All rights reserved.

No portion of this manual  
may be reproduced  
without the permission of  
Yaesu Musen Co., Ltd.

0003I-FS



Printed in Japan





Valportillo Primera, 10  
28100 ALCOBENDAS (Madrid)  
Tfno. 91-6610362 Fax 91-6617387

## DECLARACIÓN CE DE CONFORMIDAD

El que suscribe, D. Luis Cuevas Montero, como Apoderado de

ASTEC, Actividades Electrónicas S.A.  
c/ Valportillo Primera, 10  
28100 ALCOBENDAS (Madrid)  
N.I.F. A-28-444 388

DECLARA que el

Equipo: Transceptor Portátil de VHF para el S.M.T.  
Fabricado por: YAESU MUSEN CO. LTD. - Japón  
en: Japón  
Marca: YAESU  
Modelo: VX-400V

cumple con las especificaciones técnicas referidas a Compatibilidad Electromagnética (EMC) indicadas en el Certificado CE de Tipo nº 14205 emitido por Radicomunications Agency (UK).

Todo ello en cumplimiento de lo establecido en el R.D. 444/1994, de 11 de marzo, por el que se establecen los procedimientos de evaluación de conformidad y los requisitos de protección relativos a compatibilidad electromagnética de los equipos, sistemas e instalaciones, modificado por el R.D. 1950/1995, de 1 de diciembre, que incorporan la Directiva 89/336/CEE, sobre la aproximación de las legislaciones de los estados miembros relativas a la compatibilidad electromagnética, modificada por las Directiva 91/263 CEE y 93/97/CEE.

En Alcobendas a 13 de Diciembre de 1999

Luis Cuevas Montero  
Apoderado



**CERTIFICADO DE ACEPTACIÓN**

En virtud de lo establecido en el Reglamento por el que se establece el procedimiento de certificación para los equipos a que se refiere el artículo 57 de la Ley General de Telecomunicaciones, aprobado por el Real Decreto 1787/1996, de 19 de julio (Boletín Oficial del Estado número 209 de 29 de agosto), se expide por la Secretaría General de Comunicaciones, el presente certificado de aceptación a favor de:

Nombre o razón social: ASTEC ACTIVIDADES ELECTRÓNICAS S.A.  
Dirección: VALPORTILLO PRIMERA, 10, 28100 MADRID  
Teléfono: 91-6610362 Fax: 91-6617387  
Documento de identificación (CIF/NIF): A-2844388

y con número

**01 00 0061**

Para el equipo: TRANSCCEPTOR PORTÁTIL VHF PARA EL S.M.T.  
fabricado por: YAESU MUSEN CO. LTD. - JAPON  
en: JAPON  
marca: YAESU  
modelo: VX-603V  
y con certificado de examen de tipo número: 0041 00

con las advertencias indicadas en el Anexo I

acompañado de:

**Declaración de conformidad con el tipo realizada por:**

Razón social: ASTEC ACTIVIDADES ELECTRÓNICAS S.A.  
Domicilio: VALPORTILLO PRIMERA, 10  
Ciudad: ALCOBENDAS  
Provincia: MADRID

Cada uno de los equipos amparados por el presente certificado deberá incorporar la marcación siguiente:

**E D.G.Tel. 01 00 0061**

de la forma indicada en el anexo I del Real Decreto 1787/1996, de 19 de julio (Boletín Oficial del Estado número 209 de 29 de agosto).

El plazo de validez del presente certificado finaliza el 07/04/2001

Y para que surta los efectos previstos en el artículo 57 de la Ley 11/1998, de 24 de abril, General de Telecomunicaciones; modificación de la Ley 32/1992, de 3 de diciembre, expido el presente certificado.

Madrid, 17 de Febrero de 2000  
EL SECRETARIO GENERAL, P.D. Resolución de 29/09/97 (B.O.E. 03/10/97)  
El Subdirector General de Promoción y Normalización de Servicios de Telecomunicaciones

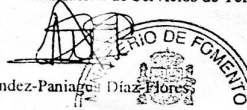

Antonio Fernández-Paniagua Díaz Flores

**ANEXO I AL CERTIFICADO DE ACEPTACION N° 01 00 0061**

Potencia Máxima .....: 5 W  
Separación de Canales Adyacentes: 12,5 / 25 kHz  
Modulación .....: Fase  
Banda Utilizable .....: 146 - 174 MHz  
Este equipo cumple la ETS 300 086 (UNE-ETS 300 086) y su utilización debe estar amparada por las correspondientes concesiones de dominio público radioeléctrico y del servicio.

# FNB-V57

## Rechargeable Battery Pack

The **FNB-V57** is rechargeable Nickel Cadmium power packs designed to match Yaesu VHF and UHF compact hand-held transceivers. Recharging can be provided by the desk-top **NC-73** Rapid Charger.

### Specifications



FNB-V57	
Capacity	1100 mAh
Number of Cells	6
Full Voltage	7.2 V
Discharged	6.0 V
Std. chrg current	110 mA

Temperature Ranges	Minimum		Maximum	
	°C	°F	°C	°F
Charge	10	50	40	104
Discharge	-20	-4	60	140
Storage	-20	-4	35	95

### Precautions & Maintenance

Before using a battery pack for the first time, charge it completely (Approx. 1.5 hours). Do not attempt to charge a pack with the incorrect charger, as this can damage or shorten the life of the pack.

Whenever charging a pack without the transceiver attached, be careful to prevent any metal objects from touching the terminals on the pack. We do not recommend using this battery pack for any equipment other than Yaesu transceivers for which the pack is specifically designed (see your transceiver manual).

		<b>CONTAINS NICKEL-CADMIUM BATTERY.</b> <b>MUST BE RECYCLED OR DISPOSED OF PROPERLY</b>
Ni-Cd	Cd	

**YAESU MUSEN CO., LTD.**  
4-8-8 Nakameguro, Meguro-Ku, Tokyo 153-8644, Japan

**YAESU U.S.A.**  
17210 Edwards Rd., Cerritos, CA 90703, U.S.A.

**YAESU EUROPE B.V.**  
P.O. Box 75525 1118 ZN, Schiphol, The Netherlands

**YAESU UK LTD.**  
Unit 12, Sun Valley Business Park, Winnall Close  
Winchester, Hampshire, SO23 0LB, U.K.

**YAESU GERMANY GmbH**  
Am Kronberger Hang 2, D-65824 Schwalbach, Germany

**YAESU HK LTD.**  
11th Floor Tsim Sha Tsui Centre, 66 Mody Rd.,  
Tsim Sha Tsui East, Kowloon, Hong Kong

### ⚠ Caution ! ⚠

**Never short-circuit the connection terminals on the battery or charger !**

When carefully maintained, a pack should be useful for about 300 charge/discharge cycles, or for up to 5 years. However, the following abuses shorten useful life of the battery, and should be avoided:

- exceeding the specified temperature limits;
- overcharging with an incorrect charger, or charging for too long;
- over-discharging. When the warning beeper in the transceiver sounds, the pack should be recharged immediately: don't let it remain discharged for more than a few days;
- shorting the terminals, or using the pack with equipment not designed for it;
- reversing charge polarity. Use only the proper charger. If this is tampered with or another charger is used, permanent damage may result;
- submersing the battery in water, or attempting to open the battery casing.
- If a battery is stored without use for more than three months, every three months it should be returned to room temperature and then recharged. For long storage periods (more than 3 months), the storage temperature range is lower than specified.

After storage, the battery should be returned to room temperature before use. It may first function at reduced capacity, but should return to full capacity after several complete charge/discharge cycles.

Replace the pack if charge life becomes very short.

The **NC-73** is provided with a "A" suffix for use with 100 VAC, with a "B" suffix for use with 120 VAC, with a "C" suffix for use with 200 VAC, with a "U" suffix for use with 234 VAC, or with a "non" suffix for use with 13.8 VDC.



E 1 2 7 2 7 0 0 0

0002T-FK

# FNB-V57

## Ni-Cd 電池パック

FNB-V57は、当社指定のトランシーバーに取り付けて繰り返し使用でき充電可能なNi-Cd電池パックです。適用機種については、カタログ等をご参照ください。

### 定格

公称容量：1100mAh  
公称電圧：7.2V  
充電時間：約1.5時間（NC-73A使用時）  
使用温度範囲：充電+10℃～+40℃  
放電-20℃～+60℃  
保存-20℃～+35℃

### 使用方法

トランシーバー本体の背面に取り付けてご使用ください。なお、輸送中の事故防止などのため、未充電の状態でお荷しておりますので、指定の方法と充電器により完全に充電してから使用してください。

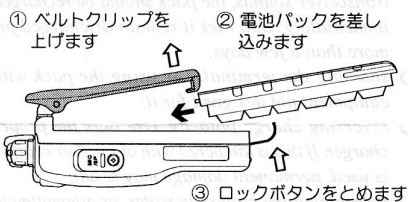

### 電池パックの正しい使いかた

Ni-Cd電池は300回以上の充放電が可能ですが、過充電や過放電などの無理な条件が重なると寿命が短くなりますので、正しい取り扱い方法およびNi-Cd電池の一般的特性について説明します。

#### 充電

当社指定の急速充電器NC-73Aを使用すると、約1.5時間で充電が完了します。

#### 充電温度

充電時の周囲温度は、+10℃～+40℃の範囲で行うようにしてください。

#### 使用条件

FNB-V57を使用するときは、周囲温度が-20℃～+60℃の範囲内にある所で使用してください。

#### 保存方法

FNB-V57を保存するときには、周囲温度が-20℃～+35℃の、腐食ガスのない湿度の低い乾燥した場所で保存してください。

3カ月以上の長期保存は、自己放電や液漏れ防止のために好ましくありませんので、3カ月に1回以上は充電を行うようにしてください。

### 安全上のご注意 —必ずお読みください—

- ⚠ **危険**
  - ⊘ 電池パックが漏液して皮膚に付着したり、目に入ると危険  
化学火傷を起こすおそれがあります。直ちに医者  
の診断を受けてください。
  - ⊘ 電池パックの端子をはんだ付けやショートをし  
ない  
火災・漏液・発熱・破裂・発火などの原因になり  
ます。ネックレスやヘアピンなどと一緒  
に持ち運ばないでください。
  - ⊘ 電池パックを火のそばや、炎天下など高温の場  
所で充電・使用・放置しない  
火災・漏液・発熱・破裂・発火などの原因  
になります。周囲温度が-20℃～+60℃  
の範囲内にある所で使用してください。
  - ⊘ 電池パックを指定機器以外の用途に使用し  
ない  
火災・漏液・発熱・破裂・発火などの原因  
になります。
- ⚠ **警告**
  - ⊘ 分解や改造をしない  
火災・漏液・発熱・破裂・発火などの原因  
になります。
  - ⊘ 水や海水などにつけたり、濡れた手で触ら  
ない  
化学変化による事故発生、または感電する  
原因になります。
- ⚠ **注意**
  - ① 電池パックの端子は、いつもきれいにす  
る  
火災・漏液・発熱・破裂・発火などの原因  
になります。
  - ① 当社指定以外の充電器を使用しない  
火災や故障の原因になります。
- ⚠ **注意**
  - ① 小さなお子さまの手の届かない場所に保  
管する  
ケガなどの原因になります。



電池パックFNB-V57に使用している  
Ni-Cd電池は、リサイクル可能な貴重  
な資源です。不要になった電池パック  
は廃棄せず、リサイクルにご協力ください。

製造元・八重洲無線株式会社

〒153-8644 東京都目黒区中目黒 4-8-8

# Main Unit

MAIN UNIT FR002430E.F

* TYPE VALUE	A BAND	C BAND
C1006	CH 15F	CH 8F
C1014	CH 15F	CH 8F
C1022	CH 15F	CH 8F
C1030	CH 15F	CH 25F
C1038	CH 15F	CH 15F
C1046	CH 25F	CH 15F
C1054	CH 15F	CH 15F
C1062	CH 25F	CH 15F
C1070	CH 15F	CH 25F
C1078	CH 15F	CH 15F
C1086	CH 15F	CH 15F
C1094	CH 15F	CH 15F
C1102	CH 15F	CH 15F
L1010	0.1uH	0.052uH
L1018	0.1uH	0.052uH
L1026	0.1uH	0.052uH
L1034	0.1uH	0.052uH
L1042	0.1uH	0.052uH
L1050	0.1uH	0.052uH
L1058	0.1uH	0.052uH
L1066	0.1uH	0.052uH
L1074	0.1uH	0.052uH
L1082	0.1uH	0.052uH
L1090	0.1uH	0.052uH
L1098	0.1uH	0.052uH
L1106	0.1uH	0.052uH
R1006	1.5k	1.8k
R1014	47k	2k

